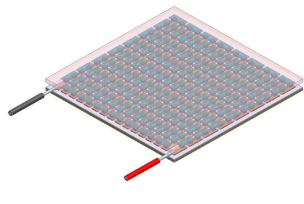

**Thermoelectric Cooler Electric and Thermal Performance**

dTmax °C	Qmax W	I <sub>max</sub> A	U <sub>max</sub> V	ACR Ohm	Th °C
72.3	43.1	5.10	14.8	2.51	27°C
82.1	47.6	5.10	16.8	2.82	50°C
91.5	51.2	4.85	18.2	3.17	75°C
94.6	52.9	4.95	19.4	3.30	85°C

**Note**

The specified performance values of the thermoelectric cooler (TEC) are determined under **standardized laboratory test conditions**. These conditions assume that the **hot side temperature (Thot)** is precisely maintained at the **ambient reference temperature (Tamb)** through adequate heat dissipation and minimal thermal resistance.

Any increase in Thot above Tamb, resulting from insufficient heat sinking or elevated thermal interface resistance, will cause the actual performance to deviate from the specified ratings

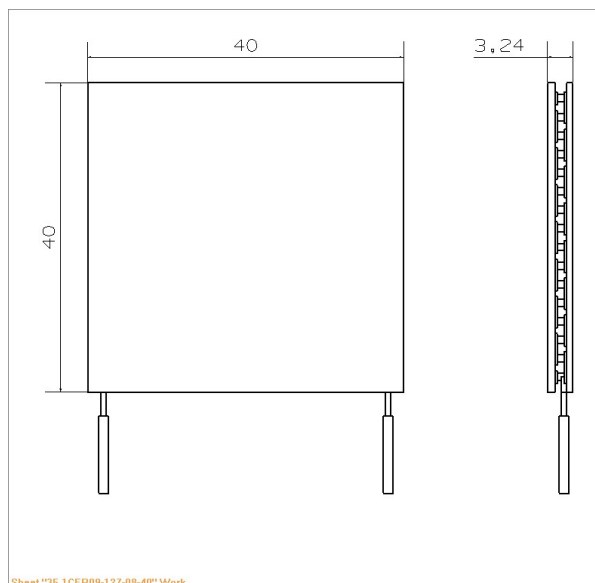
**Technical Drawing**

Dimensions are in mm

 Ceramic Material : Al<sub>2</sub>O<sub>3</sub> 96%

Solder Construction : SnAg 240°C

Sheet "35.1CE R09-127-08-40" Work

**TEC DESCRIPTION**

- Cold Side and Hot Side : bare Al<sub>2</sub>O<sub>3</sub>
- Internal Assembly: Solder Sn-Sb (T<sub>melt</sub>=230°C)
- Cold Side Surface: blank
- Hot Side Surface: blank
- Terminal Contacts : AWG-24 Wires, silicon insulated color-coded (Red/Black), multi-strand
- Bi-Te Material : high-grade, SPS type
- Protective Coating: available by request
- Laser marking: available by request

**KEY FEATURES**

- Up to 219°C short time processing (for mounting)
- RoHS EU Compliant

**SERONICS CO., LTD**

#36 Suchul-Daero, 9 Gil Gumi Gyeongbuk Korea

Web Site : www.serronics.co.kr

Tel: +82-54-468-6116 / Fax: +82-54-461-0754

**Il-Hwan Kim(Director)**

MP : +82-10-5751-3115

TEL : +82-54-468-6116

E-mail : kih3115@seronics.co.kr

## Electrical and Thermal Performance

### Installation and Orientation Guidelines

- For optimum thermal performance, ensure that the Cold Side of the Thermoelectric Cooler (TEC) is oriented toward the application requiring temperature control, while the Hot Side must be interfaced with a heat sink or other appropriate heat dissipation mechanism.
- The Cold Side of the TEC is always located opposite to the side with lead attachments.
- Lead attachment areas inherently contribute to passive heat loss. To minimize performance impact, these lead attachments should preferably be positioned on the side interfacing with the heat exchanger.

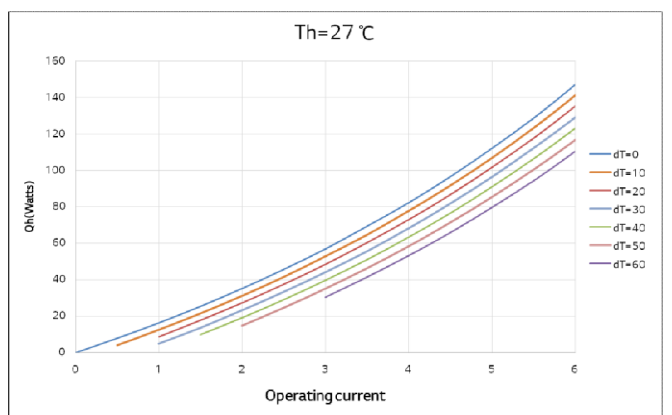
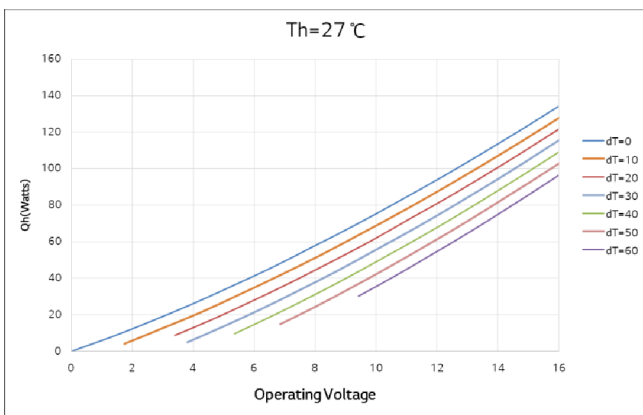
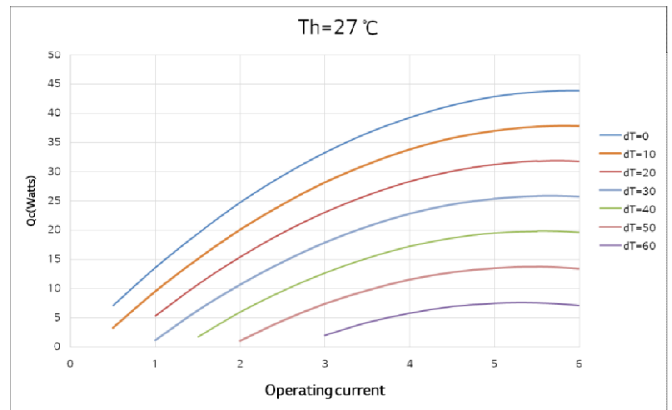
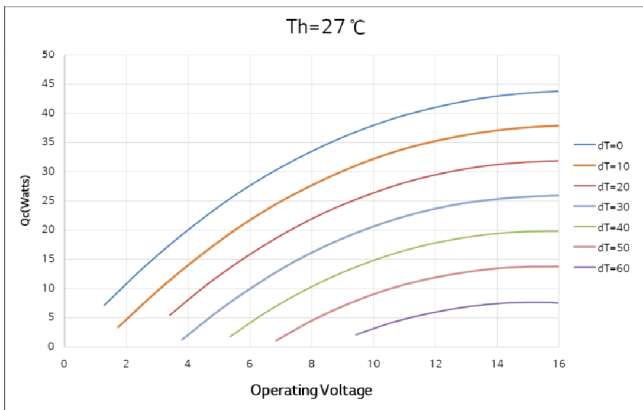
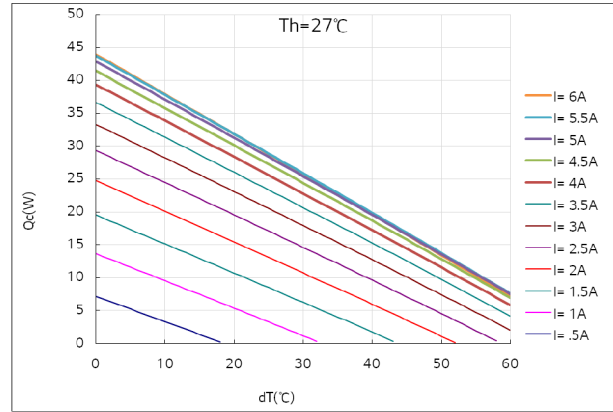
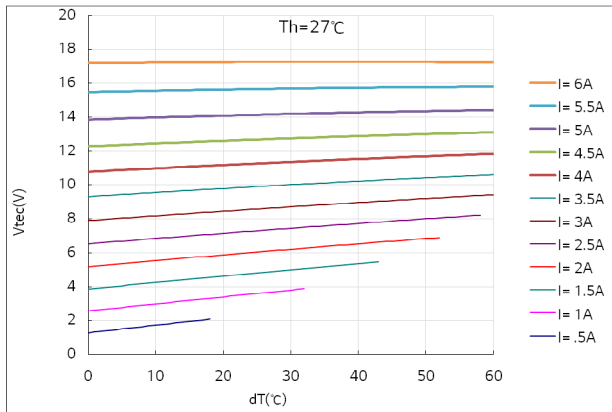

### Note

1. Max operating temperature:  $80^{\circ}C$
2. Do not exceed  $I_{max}$  or  $V_{max}$  when operating module
3. Reference assembly guidelines for recommended installation

Electrical and Thermal Performance

